

MOC457D (Sink ONLY)

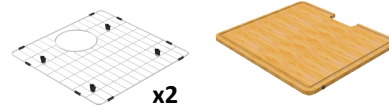

MOC457D-K1 (Standard Kit)



MOC457D-K2 (Deluxe Kit)



Montego 31" Double 60/40

Model Code: MOC457D

Included Accessories

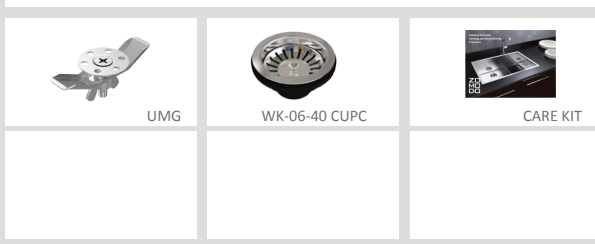

Optional Accessories



Dimensions

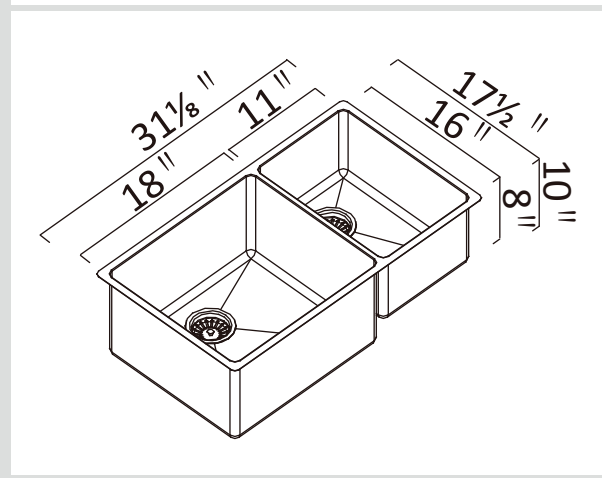

Specifications

| | |
|-------------------|---|
| Description | Double bowl, Sink |
| Overall Sink Size | 31 1/8" x 17 1/2" x 10" deep |
| Bowl Dimensions | 18" x 16" x 10" deep 11" x 16" x 8" deep |
| Installation | Undermount |
| Thickness | 18 ga |
| Material | Stainless steel SUS304 |

Installation



| | |
|------------------|--|
| Fixings | Undermount clips supplied |
| Template | zomodo.ca/product/moc457d |
| Min Cabinet Size | 33" |
| Waste Holes | 2 x 3 1/2" round Compatible with waste disposal |
| Sealing Strip | N/A |



Plumbing

| | |
|----------------|---|
| Waste Fittings | 2 x (3 1/2" x 1 1/2") basket waste included |
|----------------|---|

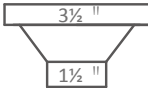
Packaging

| | |
|--------------|-----------------------------|
| Carton Type | Single Carton |
| Gross Weight | 24 lbs |
| Carton Size | 34 3/4" x 12 1/2" x 20 1/2" |

| | | |
|--|---|--|
| SURFACE FINISH  Microbrush | WASTE KIT  3 1/2" 1 1/2" | MATERIAL  SUS 304 Stainless Steel |
|--|---|--|

| | |
|--|--|
| INSTALLATION OPTIONS  Undermount | PROFILE  R15 Corner |
|--|--|

Limited 25 year Warranty: Zomodo Stainless Steel Sinks: Décor Living Innovations Inc. hereafter referred to as Décor, is pleased to offer a limited 25 year warranty with all Zomodo sinks used in normal domestic installations. Décor warrants its sinks to be free from all manufacturing defects in material and workmanship. Décor will repair or replace (at Décor's discretion), at no charge, excluding labour, any sink supplied by Décor that is proven to be defective under normal use. Please visit www.decor.ca to see full Terms & Conditions.

Zomodo Product Certification: All Zomodo pressed sinks and waste kits sold in Canada are CSA approved. All Zomodo sinks are tested and exceed the requirements of CSA standard ASME A112.19.3-2008/CSA B45.4-08 - Stainless steel plumbing fixtures. Our Waste kits are tested and exceed the requirements of cUPC Standard. Our faucets are tested and exceed both cUPC and CSA standards.