



Air Gap Body with Cover K-9110

Features

- Solid-brass cap offers years of reliable performance.
- Durable plastic body.
- KOHLER finishes resist corrosion and tarnishing.
- Includes valve body and cover.



Codes/Standards









None Applicable

KOHLER® Faucet Lifetime Limited Warranty

See website for detailed warranty information.

Available Colors/Finishes

Color tiles intended for reference only.

| Color | Code | Description |
|--|------|--------------------------|
|  | CP | Polished Chrome |
|  | SN | Vibrant® Polished Nickel |
|  | PB | Vibrant® Polished Brass |
|  | G | Brushed Chrome |
|  | BN | Vibrant® Brushed Nickel |
|  | VS | Vibrant® Stainless |
|  | BV | Vibrant® Brushed Bronze |
|  | 2BZ | Oil-Rubbed Bronze |
|  | BL | Matte Black |

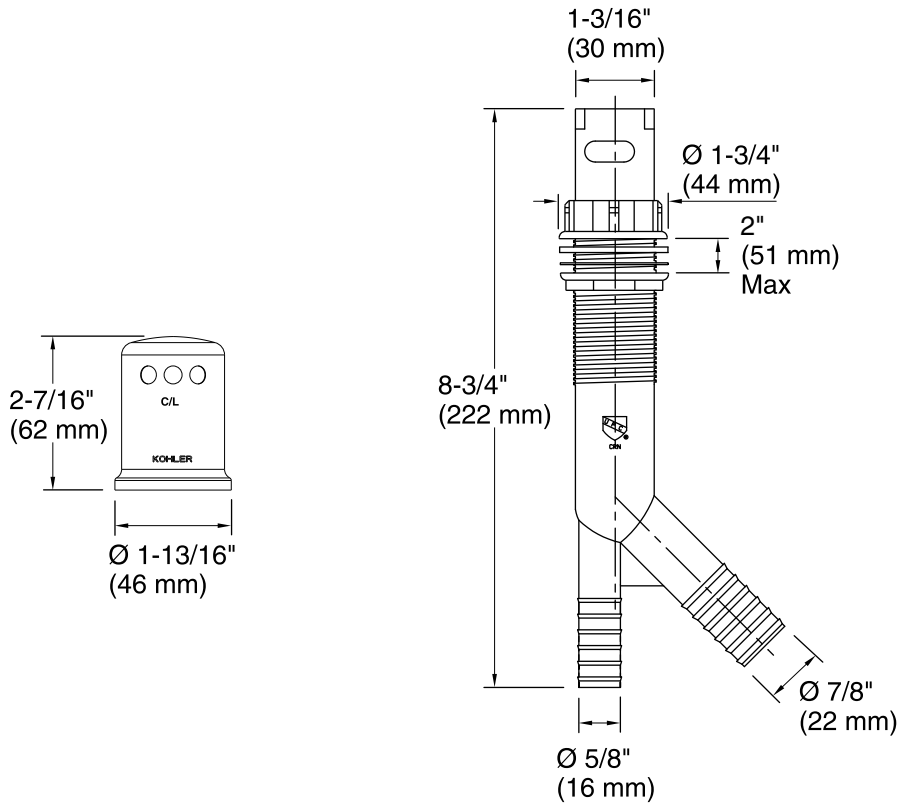

Technical Information

All product dimensions are nominal.

Material: Brass, Plastic

Notes

Install this product according to the installation guide.